



For Earth, For Life  
Kubota



KX033-4

***From compact track loaders and excavators to wheel loaders and tractor/loader/backhoes, Kubota offers a wide range of reliable, high-performance construction equipment to get the job done right.***



R065



SVL75-2/SVL97-2s

# SSV

## KUBOTA SKID STEER LOADER SSV65/SSV75

Excellent power and exceptional operator comfort bring new levels of performance and productivity to Kubota's SSV-Series Skid Steer Loaders.



©2022 Kubota Corporation

### Kubota Australia Pty Ltd

25-29 Permas Way, Truganina VIC, 3029 Australia  
Freecall: 1800-334-653  
Email: sales@kubota.com.au

Web Site: <http://www.kubota.com.au>

### Kubota New Zealand Limited

433 Rangitikei Street, Cloverlea, Palmerston North, 4412  
New Zealand  
Freecall: 0800-582-682  
Email: sales@kubota.com.au

Web Site: <http://www.kubota.co.nz>

**Kubota  
Genuine Parts**  
for maximum  
performance,  
durability and  
safety



\*This information is sourced from overseas and may not necessarily apply locally. It is essential that you confirm specifications and other information with your local Kubota dealer.



# Taking performance to all new levels of comfort and efficiency

Outstanding performance, exceptional comfort, easy maintenance, and excellent durability make Kubota's new Skid Steer Loaders the clear choice for the job.

- Outstanding performance
- Exceptional comfort
- Easy maintenance

## SSV65

Engine HP Gross (SAE J 1995): 64.0 hp (47.7 kW)  
Rated operating capacity (50% of tipping load): 885 kg  
Bucket breakout force: 2195 kg  
Operating weight: 3320 kg

## SSV75

Engine HP Gross (SAE J 1995): 74.3 hp (55.4 kW)  
Rated operating capacity (50% of tipping load): 1220 kg  
Bucket breakout force: 2669 kg  
Operating weight: 3840 kg

SKID STEER LOADER

# SSV65/SSV75





# OUTSTANDING PERFORMANCE

## Kubota engine

### Common Rail System and Diesel Particulate Filter (DPF) Muffler

The Common Rail System (CRS) electronically controls the fuel injection timing and amount in stages rather than all at once for optimal combustion; resulting in greater efficiency, better fuel economy and less engine noise. The combination of Exhaust Gas Re-circulation (EGR) and Diesel Particulate Filter (DPF) reduces the emissions making the SSV Series engine Tier IV certified.

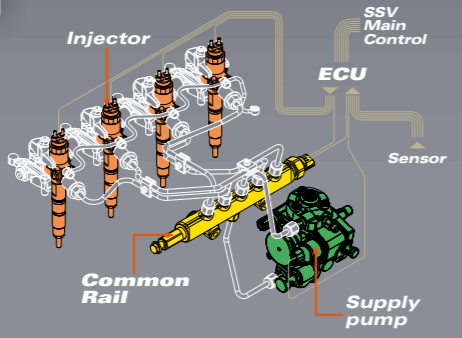

### Powerful Kubota engine

The powerful and reliable Kubota-built engine gets the job done quickly and easily with 64.0 hp\* (SSV65) or 74.3 hp\* (SSV75).

\* Engine HP Gross (SAE J 1995)

### Automatic Regeneration System

Kubota's Automatic Regeneration System burns away the soot that accumulates in the DPF muffler to keep the muffler clean and let you work longer. For safety, the automatic regeneration can be turned off when operating in fire-prone areas.



# Fast and smooth operational response

## Multi-function levers (optional)

The optional multi-function levers provide fingertip control of all major vehicle and attachment operations, including the main hydraulic line and three electrical lines, letting you keep both hands on the levers at all times for optimal operating efficiency.

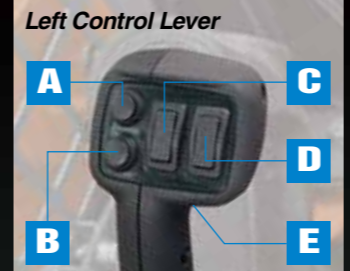

### "Hand and foot control"

- A. Horn
- B. KSR (Kubota Shockless Ride)
- C. AUX1
- D. AUX Mode Change or Turn Signal

- E. Travel Speed
- F. AUX3
- G. AUX2
- H. Proportional Aux. Switch
- I. AUX Hold Switch

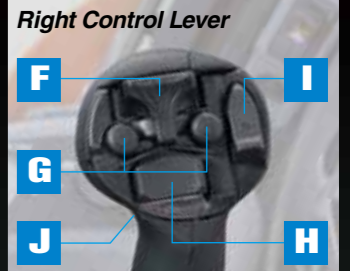
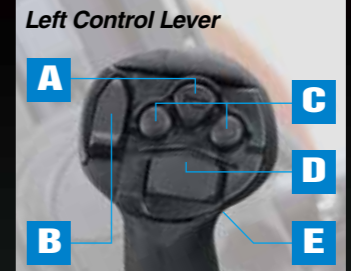

### "ISO pilot control"

- A. Horn
- B. KSR (Kubota Shockless Ride)
- C. AUX1
- D. AUX3 or Turn Signal
- E. Travel Speed

- F. Proportional AUX Switch
- G. AUX Hold Switch
- H. AUX2
- I. AUX Mode Change
- J. Float Switch

### High-flow hydraulics (optional)

The optional high-flow hydraulics system can handle attachments requiring extra hydraulic power. With high-flow hydraulics, the standard hydraulic flow increases from 68.0 l/min to 106.0 l/min on the SSV65 and from 79.0 to 115.0 l/min on the SSV75.

### Dial and foot throttle

The dial throttle is ideal for jobs that require a constant engine speed, such as cold planning, trenching, and snow blowing, and conveniently located to let you change the engine speed setting while operating the levers. The foot throttle for ISO pilot control lets the operator vary engine speed for other applications.



### Cooling system and variable fan

A hydraulically driven fan optimizes cooling and engine efficiency by varying the fan speed to maintain the appropriate water and oil temperatures. In cold weather the fan turns more slowly, allowing for faster engine warm-up.



### Electronic Travel Torque Management (ISO pilot control)

Electronic Travel Torque Management System lets you work faster with more power. The ECU constantly monitors the load of the machine to optimally control hydraulic pump output according to the load, preventing engine stalls for smoother operation even under severe conditions.





# OUTSTANDING PERFORMANCE

## Kubota's unique vertical lift design

### ● Self-leveling function

The self-leveling function maintains the position of the bucket or fork as the attachment is raised, eliminating the need to manually adjust the angle during this operation.



### ● Long reach and high bucket hinge pin height

Kubota's unique vertical lift design delivers an exceptionally long reach of 831 mm (SSV65) or 936 mm (SSV75). The tip of the arm is optimally shaped to provide an exceptionally high hinge-pin height of 3085 mm (SSV65) or 3258 mm (SSV75) for easier dumping into trucks and other lifting and dumping tasks.

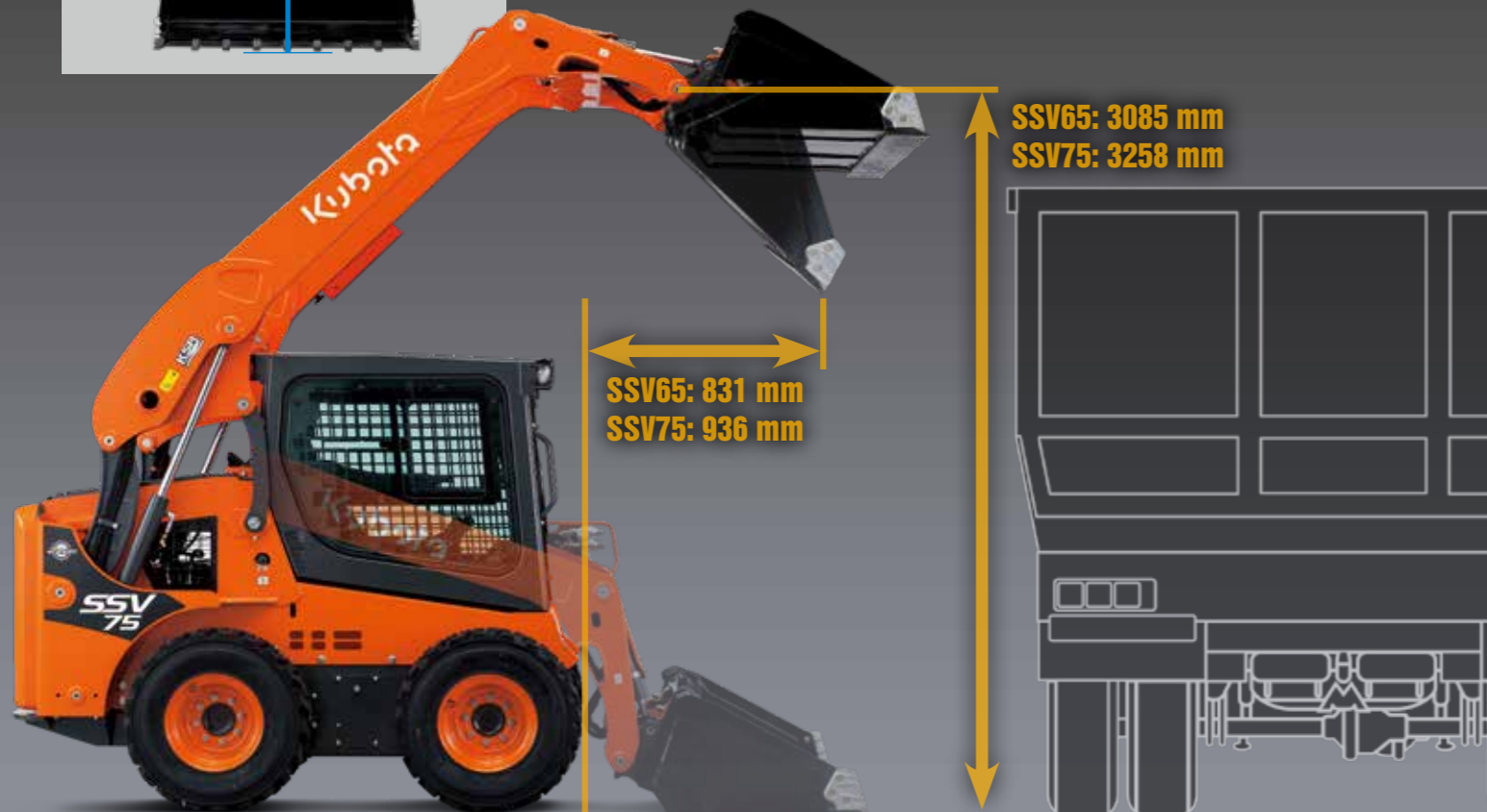

## Travel performance

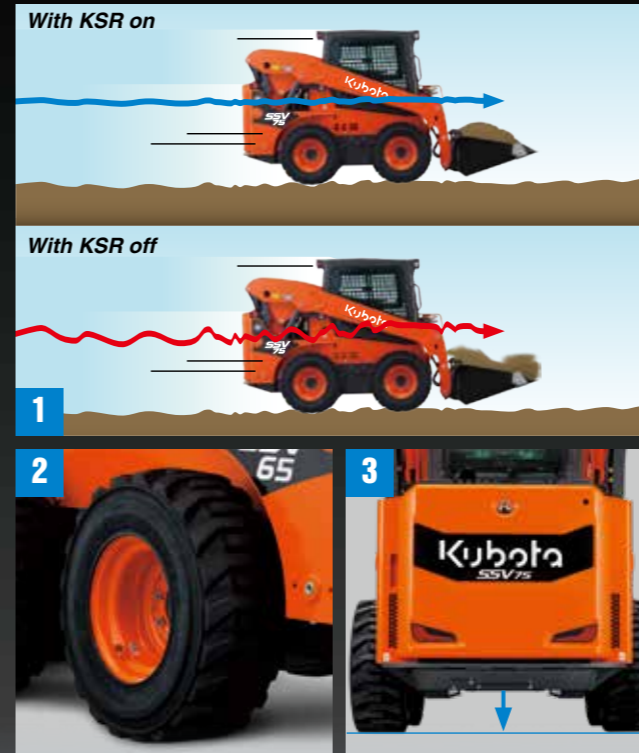

### Standard two-speed travel

Shift from low gear at 11.1 km/h (SSV65) / 11.9 km/h (SSV75) to high gear at 17.8 km/h (SSV65) / 19.0 km/h (SSV75) to get the job done faster.

### 1. Kubota Shockless Ride (KSR)

KSR helps minimize fatigue by "smoothing out" the ride. You'll appreciate KSR when carrying heavy loads over rough terrain on the farm or at a construction job site.

### 2. Heavy duty tires

The crack-resistant heavy-duty tires feature a long-wearing tread pattern for superior grip and stability. The sidewalls are wider than the wheel to prevent stones and dirt from becoming wedged between them.

### 3. High ground clearance

Travel over large obstacles with ease, thanks to the high ground clearance of 193 mm (SSV65) or 207 mm (SSV75).





# EXCEPTIONAL COMFORT AND CONVENIENCE



*Shown with ISO Pilot Controls*

## Comfortable interior

- **Excellent 360° visibility**

The edges of the bucket can be seen from the seat. Improved visibility means greater safety on the job.

- **Ready for radio installation**

The SSV-series Factory cab comes prewired with speakers already installed, all that needs to be added is the radio.

- **12V power outlet**

A convenient 12V socket can be used for recharging mobile phones and powering other small electronic devices.

- **Suspension seat**

Wide and supportive, the SSV series' suspension seat will keep you working comfortably for hours.

- **Cup holder**

A cup holder under the right armrest conveniently holds drinks to quench your thirst while on the job.

- **Front Post Switch panels**

Switch panels on the front posts provide quick and convenient access to important functions.



*Shown with ISO Pilot Controls*

## Air conditioning

- **Rear view mirror**

The wide mirror in the middle of the cabin ensures an excellent view of conditions behind the loader.

- **Ample legroom**

The spacious cabin provides ample legroom to help reduce operator fatigue.



*Shown with ISO Pilot Controls*

- **Optimized air conditioning**

Optimized airflow through nine vents provides outstanding cooling and heating comfort throughout the year.

- **Enhanced defrosting and demisting functions**

Ample airflow prevents the windows from fogging up or freezing during the cold months of the year.





# EXCEPTIONAL SAFETY AND FUNCTIONALITY

## Rugged exterior

### Sliding front door

Standard on all closed-cab models, the tall and wide sliding front door can be opened regardless of the loader position, ensuring quick and easy entry and exit.



### ● ROPS/FOPS cabin

The OSHA-certified ROPS/FOPS cabin provides protection in the event of accidental rollovers or falling objects.

### ● Bolt-on replaceable handles

The handles are bolted to the cab to allow for quick and easy replacement in the event they become damaged.

### Pressurized Cab

The pressurized cab keeps out dust, flying debris, and insects so that you can work comfortably with fewer distractions. Lower noise levels let you work long hours with minimal fatigue.



### ● Sliding side windows

The front sections of both side windows slide open towards the back of the cab.



### ● Side-window grille

The side-window grilles are installed on the inside to let you easily clean the outer glass surfaces of the windows.



### ● Rear lights

### ● Front and side work lights

### ● Turn signals (optional)

### ● Coupler protection

### ● Aux. hydraulic lines routed inside the arm

### ● Cylinder protection plates





# EASY MAINTENANCE

## Simple Access



### ● Routine checks

The rear door opens wide, providing access to all components for daily routine inspection.

- A. Engine oil filler tube
- B. Engine oil dipstick
- C. Battery
- D. Engine oil filter
- E. Diesel fuel filler tube
- F. Air cleaner indicator
- G. Air cleaner
- H. Coolant reserve tank
- I. Water separator
- J. Fuel filter
- K. Door lock

### ● Easy battery access

The battery is easily accessed without tools.



### ● Door enclosed fuel tank and easy refill access

No need to open the door. Simply lift a flap for quick and easy refueling.



### ● Mud-cleaning ports

Three mud-cleaning ports ensure fast and simple removal of mud and debris from the lower part of the machine.

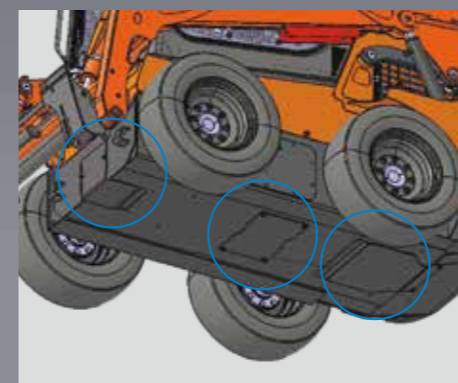

### Top-mounted radiator and oil cooler

Conveniently located on the top of the engine compartment, the radiator components are protected from damage from the rear yet within easy reach for cleaning and routine maintenance.



### ● Tilt-up cabin

The cabin can be tilted 64° without having to lift the arm, allowing easy access to the hydraulic pumps, valves, lines and hydraulic tank.



### ● Easy-clean Floor Mat and Drain Outlet

The soft rubber floor mat is easy to remove and clean. And with the built-in drain outlet, the mat can be washed in the cab.



*Shown with ISO Pilot Controls*



# VERSATILITY

With a wide variety of attachments available\*, Kubota skid steer loaders are the most versatile machines on the jobsite.

\*Not all attachments are OEM-KUBOTA.

## Bucket



## Pallet Fork



## Standard Hydraulic Coupler

With the standard hydraulic quick coupler, you can attach or remove attachments using a switch without leaving the seat.



# EQUIPMENT

## STANDARD EQUIPMENT

- Open CAB (ROPS/FOPS Level1)
- Top/Rear window
- Type of Control (Hand & Foot control/ ISO pilot control)
- Suspension Seat
- 2" Retractable seat belt
- Fold down arm rests
- Dial throttle
- 12V electric outlet
- Radio Ready
- Horn
- Backup alarm
- Work lights (Front 2/Rear 2)
- Side lights
- Bucket Cylinder Guards
- Protection for AUX coupler
- Heavy Duty Tire  
SSV65 10-16.5  
SSV75 12-16.5
- Kubota Shockless Ride (KSR)
- Self leveling (on/off)
- Hydraulic quick coupler

## OPTIONAL EQUIPMENT

- High flow hydraulics
- Multifunction lever
- 14 pin coupler for attachments
- Door lock key
- Hazard Lamp/Turn Signals
- Polycarbonate door
- ...and much more.

# SPECIFICATIONS

Model		SSV65	SSV75		
Type of operator station		Closed CAB	Closed CAB		
Model		V2607-CR-TE4	V3307-CR-TE4		
Emission certification		Tier 4	Tier 4		
Engine	Gross HP (SAE J1995)	HP (kW)/rpm	64.0 (47.7)/2700	74.3 (55.4)/2600	
	Net HP (SAE J1349)	HP (kW)/rpm	61.3 (45.7)/2700	71.6 (53.4)/2600	
	Displacement	cc	2615	3331	
	Cylinders		4	4	
	Bore Stroke	mm	87 × 110	94 × 120	
	Aspiration		Turbocharged	Turbocharged	
Loader performance	Rated operating capacity-50% tipping load	kg	885	1220	
	Tipping load	kg	1770	2440	
	Breakout force	Bucket	kgf	2195	2669
		Lift arm	kgf	1750	2200
Lift arm path			Vertical	Vertical	
Power train	Standard tire size		10-16.5-8PR	12-16.5-10PR	
	Chain size ASA#		80	100	
	Travel speed	Low	km/h	11.1	11.9
		High	km/h	17.8	19.0
	Traction force		kgf	3329	3853
	Ground clearance		mm	193	207
Hydraulic system	Loader hydraulic flow		ℓ/min.	68.0	79.0
	Loader hydraulic pressure		kgf/cm <sup>2</sup>	230	230
	Aux. hydraulic flow	Standard	ℓ/min.	68.0	79.0
		High	ℓ/min.	106.0	115.0
Service refill capacities	Hydraulic tank		ℓ	16.0	16.0
	Fuel tank		ℓ	96.0	102.0
Operating weight (Include operator weight 79 kg)		kg	3320	3840	

The company reserves the right to change the above specifications without notice. This brochure is for descriptive purposes only. Please contact your local Kubota dealer for warranty information. For your safety, Kubota strongly recommends the use of the seat belt in almost all applications.

# DIMENSIONS

## SSV65 / SSV75

